

# 3000 Series

UK Manual  
Accessories  
Warranty Registration



Made in Great Britain

Your Ebac Dehumidifier has been specifically designed to cope with Britain's unique and unsettled climate by Europe's No.1 manufacture of dehumidifier



# Contents

---

<b>Introduction</b>	<b>4</b>
<b>Unpacking your dehumidifier</b>	<b>4</b>
<b>Setting up your dehumidifier</b>	<b>5</b>
<b>SMART Control™</b>	<b>5</b>
<b>3000 Series Parts</b>	<b>6</b>
<b>Settings &amp; Controls</b>	<b>7</b>
<b>Emptying the water container</b>	<b>9</b>
<b>Cleaning the filter</b>	<b>9</b>
<b>Troubleshooting</b>	<b>10</b>
<b>Technical and Safety Information</b>	<b>13</b>
<b>Accessories</b>	<b>14</b>
<b>Warranty Registration</b>	<b>17</b>
<b>Useful Contacts</b>	<b>19</b>

# Introduction

---

At Ebac we pride ourselves on being the dehumidifier experts. With over 40 years experience we have helped over 1 million customers remove excess moisture from their homes. Our range of products (all designed and manufactured in the UK) reflects our years of expertise and provides an option for every home.

The first time you plug in your new Ebac dehumidifier you'll begin to realise the difference it will make to your home. You'll be amazed at just how much water this quiet, yet powerful unit extracts and stores in its container. It's sure to get you thinking where it all comes from and where it's been going all those years.

Incredibly, the average family produces 20 pints/12 litres of moisture a day. However, that's one fact you needn't worry about now. Your Ebac dehumidifier is designed to cope with everything you do that adds even more moisture to the British climate. Everything from showering to washing up, boiling a kettle to breathing; they all add moisture to the air.

Once your condensation problem is under control, your dehumidifier will extract from 1 to 2.5 litres of water per day.

This manual will help you get the very best out of your Ebac and not only protect your home from the damaging effects of condensation and damp, but also improve the quality of your air.

## Unpacking your dehumidifier

---

Please ensure that all packaging is disposed of or stored safely where it will not be a danger to children or pets.

In the unlikely event of having to return your dehumidifier for repair, cardboard packaging will be required. You may wish to consider this before disposing of the packaging. Stand your dehumidifier upright for a minimum of 2 hours before switching on.

## Technical and Safety information

---

Min Operating Temperature	3°C
Max Operating Temperature	35°C
Fuse Rating	13A

- Do not use the machine if the power cord or cabinet are damaged.
- If the flexible power cord is damaged it must be replaced by an identical cord which is available from Ebac Limited or an Ebac authorised distributor.
- Do not poke objects into any grilles on the machine.
- This machine complies with EMC/RFI directive EN60555 (BS800).
- Ebac has a policy of constant development and, therefore, reserves the right to change specifications without prior notice.
- Do not use the machine without the permanent drainage bung in place on the back of the machine.
- Your dehumidifier should not be located in such a way that it will become an obstacle or hazard.
- Your dehumidifier should not be placed directly at the top of the stairs.
- To protect against electrical shocks, do not immerse unit, plug or cord in water, or spray with liquids.
- Do not use an extension cord or double adapter.
- Ensure Power supply is RCD protected at 30mA.

**Please note:** This dehumidifier should not be used by children and by persons with reduced physical, sensory or mental capabilities, unless they have been given instructions on the safe use of the appliance and they understand the hazards involved. Children should not play with the dehumidifier and any maintenance or cleaning of the product should not be made by children.

# Setting up your dehumidifier for maximum performance

---

## Location

Unless you have a particular area in need, we suggest that you place your dehumidifier in the coldest, dampest part of the home or alternatively in a central location ensuring that safety is paramount.

Since moisture rises, first floor location is preferable.

Place the dehumidifier away from direct heat source. As the unit uses a cold surface to collect moisture, direct heat will reduce its ability to do so.

Doors should be kept ajar to ensure good air flow throughout the home.

Your dehumidifier will not operate should the temperature drop below 3°C.

## Operation

Unless you have a severe problem with excess moisture or damp, we recommend plugging in the dehumidifier and running on SMART Control (see *Switching on your Dehumidifier*, page 7)

Your dehumidifier should run on this setting continuously for 24-48 hours when switching on for the first time.

It will then switch on and off automatically at the most economical times to keep the humidity at the correct level.

In the event of needing to increase air flow and water collection, the dehumidifier can be run on MAX for a set period of Time or Continuously.

## Comfort

The compressor will make a humming noise similar to that of your fridge freezer. We recommend that the dehumidifier is not placed directly onto a hard floor as this will increase and amplify the sound.

To ensure that your sleep pattern is not disturbed, the dehumidifier is best suited to be located away from your bedroom door.

## Smart Control

---

Set your Ebac 3000 to Smart Control™ and let it do all the hard work. Ebac's patented Smart Control™ technology continuously monitors and learns about environmental factors in and around your home so that it knows when it needs to work and when it doesn't. This reduces running time and ensures lower running costs.

Throughout this manual Smart Control™ will be referred to as SMART Mode.

# 3000 Series Parts

---

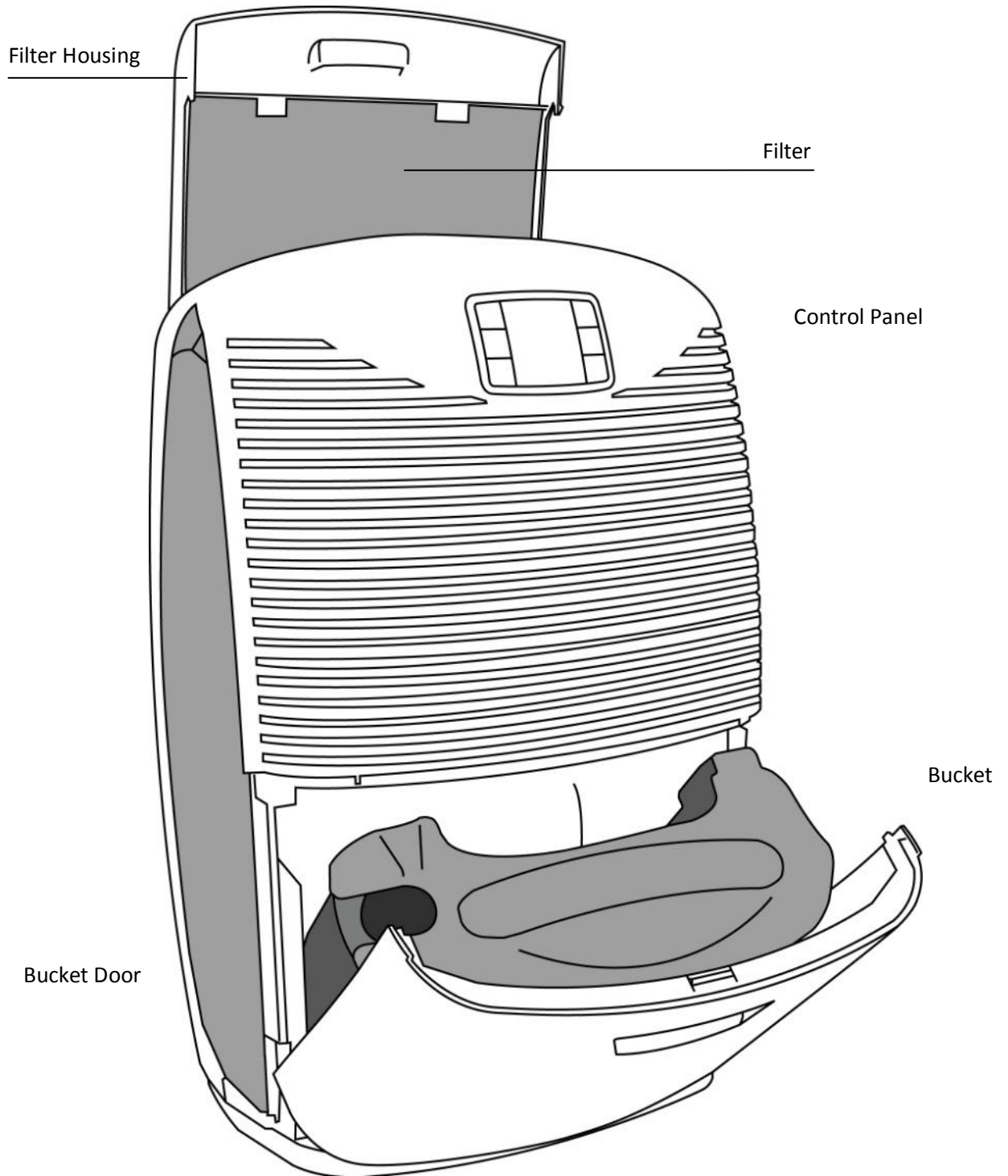

## Settings & Controls

---

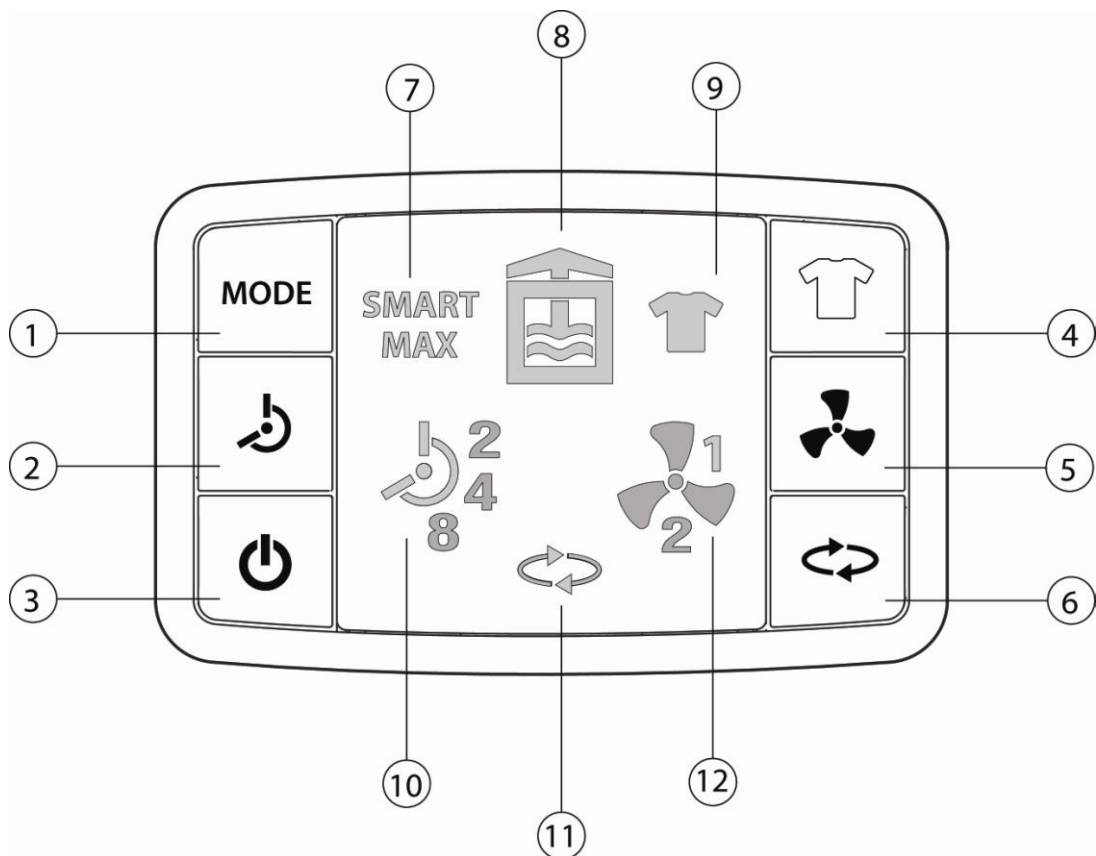

Please refer to the image above when numbers are indicated within the instructions

### Switching on your dehumidifier

---

**Stand your dehumidifier upright for a minimum of 2 hours before switching on.**

Remove the bucket and plug the unit in

- The Status light (8) will be illuminated red indicating the water bucket is not present.
- This is the same red light that will illuminate when the bucket is full.

Place the bucket in the unit and close the door

- The Status light (8) will now be illuminated blue; the unit is now operating.
- The unit will start running in SMART mode. We recommend that you use this setting permanently unless you have a problem with damp or would like to dry laundry (see Using the Laundry Drying Function).

## Selecting different Modes

---

Press the MODE button (1) and MAX will illuminate on the display

- *The unit is now running at MAX capacity on a fan speed setting of 2 (high). The unit will now run continuously.*

Press the MODE button (1) again and SMART will illuminate on the display

- *This unit is operating in SMART mode and the fan speed will decrease to 1 (quiet/normal).*

## Changing the Fan Speed

---

Press the FAN button (5) to cycle through the fan speeds

- *The FAN symbol (12) will illuminate showing either a number 1 (quiet/normal) or number 2 (high) depending on the speed selected.*
- *Fan speed can only be changed in SMART, MAX or AIR PURIFYING Mode.*

## Using the Laundry Drying Function

---

Press the LAUNDRY button (4) and the laundry symbol (9) will illuminate

- *The unit is now set to operate at the highest fan speed at maximum capacity.*
- *The unit will run for the highlighted time (10) before reverting to SMART Mode.*

Press the TIMER button (2) to change the length of time LAUNDRY mode will operate

- *The order the times will cycle through is as follows: 2hrs – 4hrs – 8hrs – 2hrs*

## Using the Air Purifying Mode

---

Press the AIR PURIFYING button (6) and symbol (11) will illuminate

- *The unit is now in Air Purifying mode. The dehumidifier will now stop extracting moisture from the air and simply pull air through the filter to remove any impurities before re-circulating it.*

Set unit to Quiet (slow) Air Purifying mode

- *Press the fan button (5) until a number 1 is illuminated next to the fan symbol (12).*

Set unit to high speed Air Purifying mode

- *Press the fan button (5) until a number 2 is illuminated next to the fan symbol (12).*

## Using the Timer Function

---

Press the TIMER button (2) to cycle through the options

- *The order the times will cycle through is as follows: 2hrs – 4hrs – 8hrs – 2hrs*
- *The Timer function is available in MAX and LAUNDRY DRYING modes.*

## Switching unit to Standby

---

Press the STANDBY button (3)

- *The Status light (8) will now be illuminated orange; the unit is now in STANDBY mode.*



## Emptying the water container

---

The Status symbol on the control panel will illuminate red when the container is full. When this occurs, water collection stops.

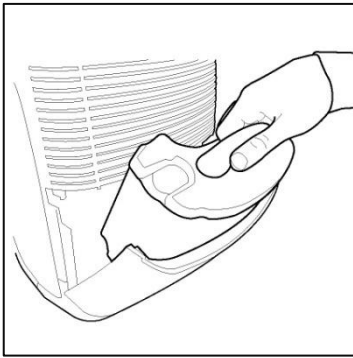

To Empty, Open the water container access door

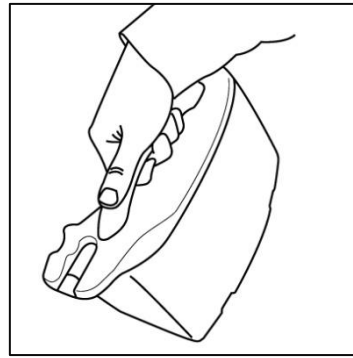

The container can then be removed and emptied as shown.

Replace the container back into the dehumidifier with the outlet on the left hand side and gently close the door.

## Cleaning the filter

---

Your Ebac 3000 has a filter to remove dust from the air.

This filter should be cleaned every month and replaced every 4 months. Failure to do this will reduce the performance of your dehumidifier and may over time lead to a permanent reduction in performance.

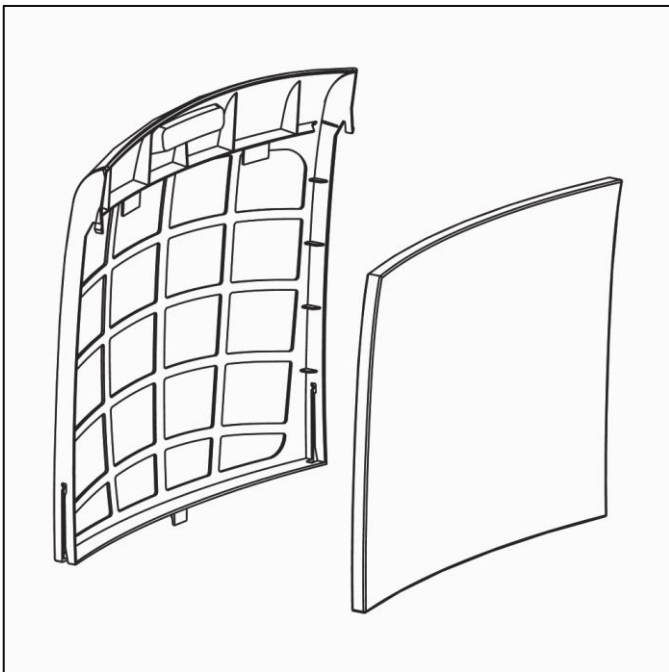

Remove the filter from the rear of the unit by sliding the filter housing upwards

Take the filter out of the housing and clean the filter using a vacuum cleaner with a soft furnishings attachment

Slide the filter housing back on to the rear panel of the unit

# Troubleshooting

---

## **The unit has no power**

Are there any signs of power to the unit, is the display illuminated, is the fan blowing or Compressor running?

- *Is the unit plugged into a power supply?* – Check someone hasn't disconnected the unit.
- *Is the mains supply working?* – Try another appliance in the socket, there may be no power from the socket.
- *Has the fuse been replaced?* – We suggest that you replace the fuse with the correct type for this model, if it continues to blow the fuse the unit is faulty
- 

## **There is a constant red light on the unit**

Is the display showing a red light constantly as if the water container is not present or is full?

- *Is the water container inserted and empty?* – Remove and replace the water container, ensuring it is inserted correctly – See *Emptying the Water Container*, pg6.
- *Does the float inside the water container move freely?* – Remove and empty any water from the water container. Now turn the container upside down and visually check that the float moves freely.
- *Is the micro-switch present?* – Check the micro-switch lever (plastic lever located behind the bucket – See *Diagram A*) is present and working correctly. When you press this lever the fan should start up and the display should illuminate.

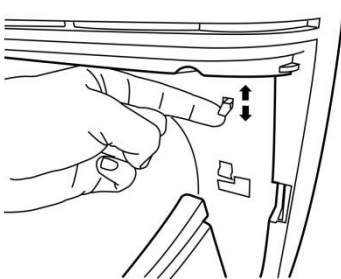

Diagram A

## **The unit is noisy**

Please bear in mind that there will always be a level of noise due to the fan & compressor, this will typically be louder than your fridge freezer.

- *Have you had the unit for a sufficient length of time?* – It is normal for a new customer to think that the unit is noisy, within a week or 2 it will just become a background noise.
- *Is the unit positioned correctly?* – If the unit is on wooden/laminated flooring this could make the unit sound louder, within a week or 2 it will just become a background noise.
- *Is the unit excessively noisy?* – Some noise is normal due to the compressor and refrigeration circuit however if you believe the unit has become louder it may require a repair.

## Troubleshooting Cont...

---

### **The unit has a low water collection**

The unit is operating as normal but appears to be collecting less water.

- *Is the unit being run on economy setting?*
  - The economy setting is not suitable for all conditions try running the unit on AUTO and see if the collection increases.
- *Have you had the unit for a sufficient length of time?*
  - As a new customer, you may feel that the collection of water has reduced after the initial installation, this is normal.
- *Have the weather conditions changed recently?*
  - If the weather is very cold / freezing there is less moisture in the air and the unit will collect less water.

### **The unit is not collecting any water**

The unit is operating as normal but is collecting NO water.

- *Is the unit on the correct setting?*
  - Ensure it is not being run on a Fan only setting.
- *Has the unit been running for a reasonable period of time?*
  - 24 hours should be sufficient time for you dehumidifier to collect water however we also suggest running the unit on the Maximum setting for 24 hours.
- *Is the unit being operated close to a heat source?*
  - Ensure the unit is placed in a suitable location – See *Placing you dehumidifier for maximum performance.*

### **The unit is overflowing**

The unit is operating as normal but is continuing to operate after the water container is full.

- *Does the float inside the water container move freely?*
  - Remove and empty the water container. Now turn the container upside down to check that the float moves freely – See *Diagram B.*
- *Does the unit continue to operate when the water container is not present?*
  - Remove the water container from the unit. The red light should be illuminated and the compressor should not operate.
- *Is the micro-switch lever present?*
  - Check the micro-switch lever (plastic lever located inside the bucket cavity – See *Diagram A, pg9*) is present and working correctly. When you press this lever the fan should start up and the display should illuminate.

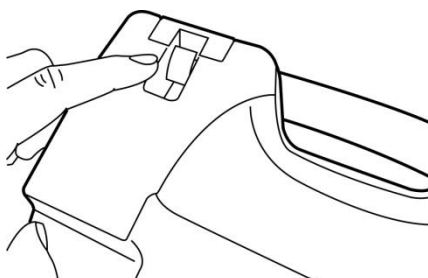

Diagram B

## Troubleshooting Cont...

---

### **The unit is icing up**

The unit is operating as normal but is creating a lot of ice at the rear of the unit.

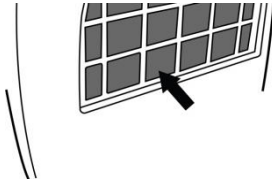

Diagram C

- *Is there thick ice on the coil which does not disappear?*
  - It is normal for a thin layer of ice or frost to form on the coil – See *Diagram C*, but this will disappear when the unit defrosts.
- *Is the unit being run in the correct environment?*
  - The unit should be run in a domestic environment with an ambient temperature of 3°C or above?

### **The unit is leaking**

The unit is operating as normal but is leaking water.

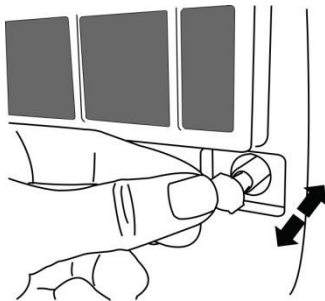

Diagram D

- *Is the back of the unit leaking?*
  - Ensure that the drainage bung is inserted correctly in the rear of the unit – See *Diagram D*.
- *Is the container leaking?*
  - Check that the container has no leaks by filling it with water over a sink.
- *Is the unit on a level surface?*
  - The unit may leak if it is not placed on a level surface. Your dehumidifier should always be placed on a level surface for this reason.

### **There is a problem with the display**

The unit appears to be operating as normal but the display is incorrect (Froze / No Fan Symbol etc)

- *Have you tried resetting the unit?*
  - Unplug the unit and plug it back in. This will reset the unit and may resolve the problem.

### **The unit is damaged**

The unit has been delivered damaged or has become damaged since purchase.

- *Can the damaged part be replaced?*
  - If the Water Container / Filter Housing are damaged, we can supply a replacement without the need to return the unit to us.

- *If the damaged part cannot be replaced we recommend you contact the customer service team on 0845 634 1392, who will advise the best course of action.*

---

All information contained in this section can be found on our website and in the unlikely event of needing to return your dehumidifier for a repair, please go to:

**[www.ebac.com/contact](http://www.ebac.com/contact)**

Alternatively call our customer service team on **0845 634 1392** during normal hours with the following information to hand:

- **Dehumidifier serial number** (located on a rating plate behind the water container)
- Your **postcode** and **when and where you purchased** your dehumidifier.

# Accessories

---

Some or all of the following accessories may have been included with your Ebac Dehumidifier. Those that are not included can be purchased for an additional charge from your local retailer or [www.ebac.com](http://www.ebac.com)

## Permanent Drainage Kit (optional extra)

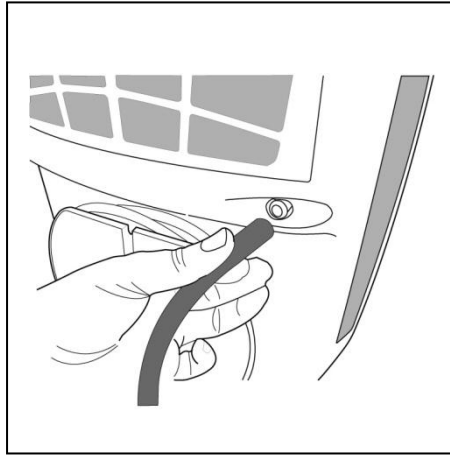
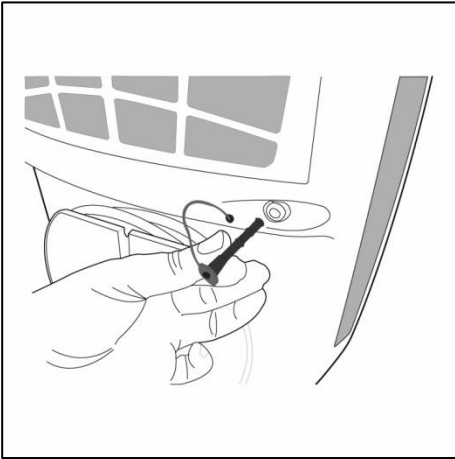

## Castors (optional extra)

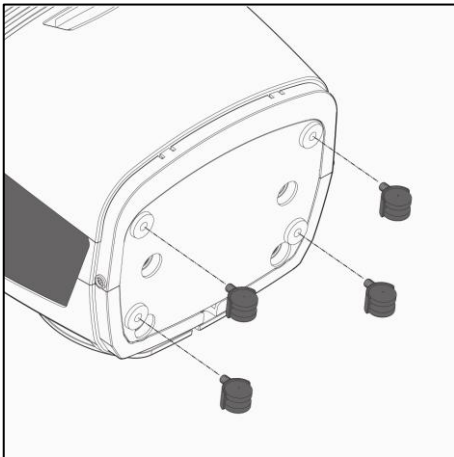

## Fragrance Filter (optional extra)

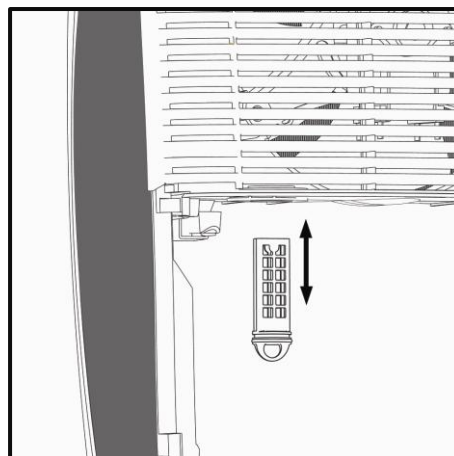
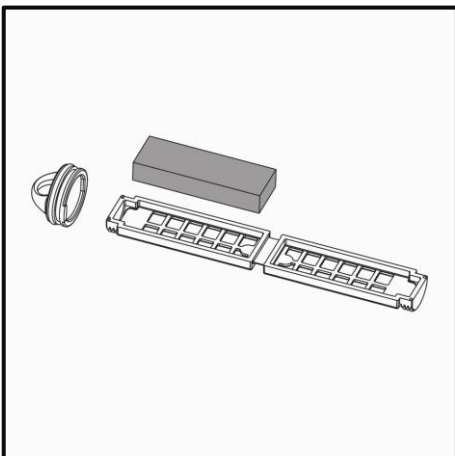

## Accessories

---

### Annual Standard Filter Pack

Part no. DIA023

Contains 3 standard filters. The standard filter will remove dust particles as air is passed over the filter.

**£18.99**

### Annual Activated Carbon Filter Pack

Part no. DIA021

Contains 3 Activated Carbon Filters. Carbon filters are ideal for homes with pets or smokers as they remove odours from the air creating a more pleasant atmosphere.

**£19.99**

### Castor Kit

Part no. DIA020

Although lightweight and portable adding a castor kit to your dehumidifier makes it easier to move as it can be simply wheeled to a desired location.

**£14.99**

### Drainage Kit

Part no. DDA110

The permanent drainage kit allows your dehumidifier to be used in unoccupied situations such as holiday homes, cellars etc without the need for the water container to be emptied

**£12.49**

### Replacement Filter Housing

Part no. DIC007

The filter housing is specific to the 3000 series dehumidifiers.

**£4.99**

### Replacement Water Container

Part no. DIA028

Replacement water container in case anything should happen to the one supplied with your dehumidifier.

**£19.99**

Prices are subject to change. For the latest prices and special offers log on to

**[www.ebac.com](http://www.ebac.com)**

## How to purchase

---

- Online

Log on to **www.ebac.com**

- Post

Complete and send the attached form to:  
**Ebac Ltd, Ketton Way, Aycliffe Business Park, Newton  
Aycliffe, County Durham, DL5 6SQ**

## Accessory Details

---

Part No.	Accessory	Price	Total

## Your Details

---

Title: ..... Initials: ..... Surname: .....

Address: .....

.....

.....

Postcode: ..... Country: .....

Telephone: ..... Mobile: .....

Email: .....

## Payment Details

---

I enclose a cheque/postal order for

£ ..... Payable to Ebac Ltd

+ £3.95 Postage and Packaging

## Warranty Registration

---

Thank you for purchasing an Ebac Dehumidifier. Your dehumidifier is covered by a standard one year warranty from the date of purchase\*. Registration of your unit ensures you can take full advantage of your warranty so don't hesitate and register today.

## How to Register

---

There are two simple methods of registering your Ebac Dehumidifier Warranty

- **Online** Log on to **[www.ebac.com/warranty](http://www.ebac.com/warranty)**
- **Post** Complete and send the attached form to:  
**Ebac Ltd, Ketton Way, Aycliffe Business Park, Newton Aycliffe, County Durham, DL5 6SQ**

## Why Register?

---

There are three Reasons to register your Ebac Dehumidifier:

1. You can take full advantage of your Ebac warranty.
  - Fast repair service carried out by Ebac with the unit collected and delivered from and to the place most convenient to you.
  - All parts and labour included.
2. Your details are on record which enables us to help you much faster.
3. You can receive the latest product information and up to date offers.

## What's covered?

---

- Your dehumidifier will receive unlimited repairs for any mechanical failure within the period of the warranty.
- The costs associated with the collection, repair and return delivery of the dehumidifier.
- The warranty covers dehumidifiers in domestic use in Great Britain and Northern Ireland.
- Visit [www.ebac.com/warranty](http://www.ebac.com/warranty) for Terms and Conditions.

## What's not covered?

---

- The warranty does not cover wear and tear to the unit exterior or air filter. You may be charged if no fault is found or the fault is due to user error.
- The warranty does not cover accidental damage.

*In the event of a breakdown, log on to **[www.ebac.com/faq](http://www.ebac.com/faq)** and use our quick and easy diagnostics system to resolve your problem without the need to speak to one of our Customer Service Team.*

*Alternatively call our customer service team on 0845 634 1392 during our normal hours.*

This warranty does not affect your statutory rights as a purchaser.



## About You

---

Title: ..... Initials: ..... Surname: .....

Address: .....

.....

.....

Postcode: .....

Telephone: ..... Mobile: .....

Email: .....

## About Your Dehumidifier

---

Model No.\* ..... Serial No.\* .....

\*Located behind the water container or on the rear panel

Date of Purchase: ..... / ..... / ..... Purchase Price (£): .....

Where did you buy your unit: .....

## Warranty Required

---

Register my one year warranty and receive 2<sup>nd</sup> year free

Register and extend my warranty to five years and I have enclosed a cheque for £45 payable to Ebac Ltd

ONLY AVAILABLE IF APPLIED FOR WITHIN 30 DAYS FROM THE DATE OF PURCHASE

**If you purchased your Dehumidifier direct from Ebac please ignore this form as your warranty has already been registered**

## Useful Contacts

---

- **Online** Log on to **[www.ebac.com](http://www.ebac.com)**
- **Email** **[customer.services@ebac.com](mailto:customer.services@ebac.com)**
- **Telephone** **0845 634 1392**





Ketton Way, Aycliffe Business Park, Newton  
Aycliffe, County Durham, DL5 6SQ, United Kingdom

Tel: 0845 634 1392 | +44 (0)1388 605061



Where you see this symbol on any of our electrical products or packaging, it indicates that the relevant electrical products should not be disposed of as general household waste in Europe. To ensure the correct waste treatment of the product, please dispose of it in accordance with any applicable local laws or requirements for disposal of electrical and electronic equipment in so doing, you will help to conserve natural resources and improve standards of environmental protection in treatment and disposal of electrical waste.

Ref: DIL001-V4